

Parts List		
Item	Qty	Part Number
1	1	3mm Perspex
2	1	5mm Perspex
3	7	TOGGLE SWITCH LARGE (NOSE STEERING)
4	4	SAFETY SWITCH GUARD BLACK v1
5	7	ANNUNCIATOR BOX V1
6	1	ELEC PUSH BUTTON
7	1	Component6
8	1	SAFETY SWITCH GUARD BLACK v1 (1)
9	6	DZUS FASTENER PLASTIC

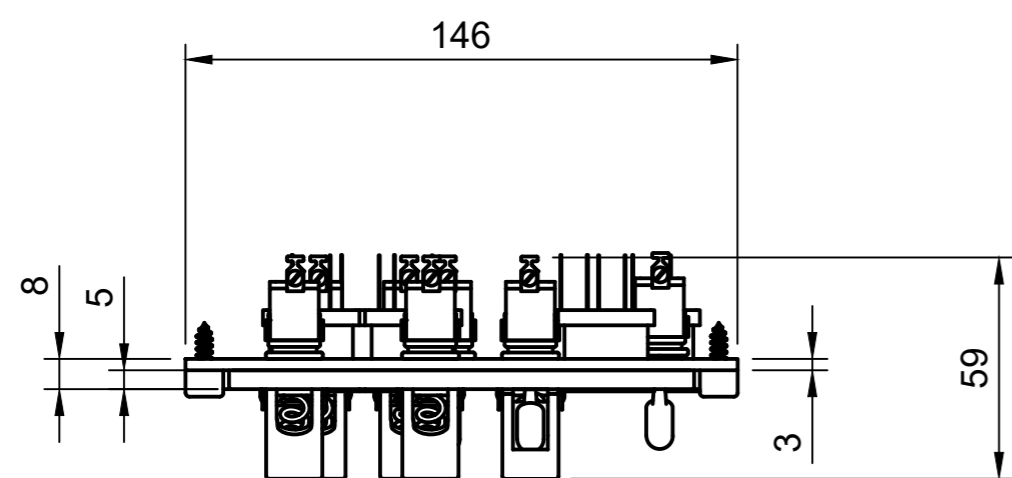

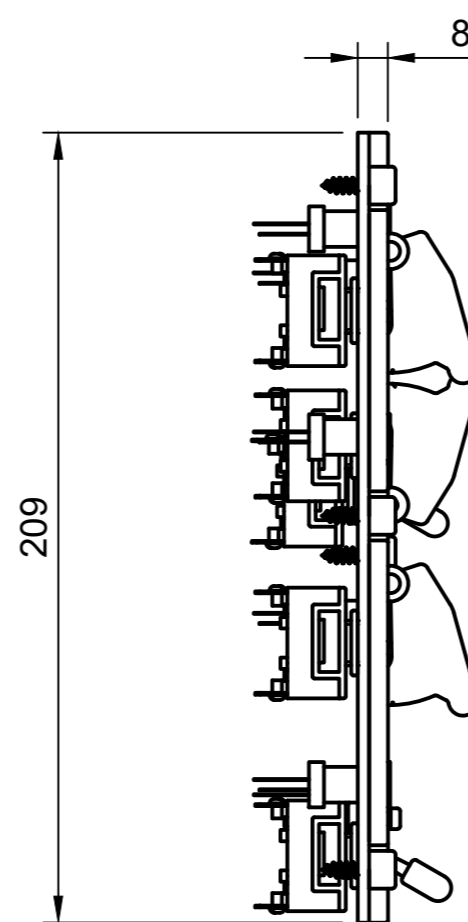

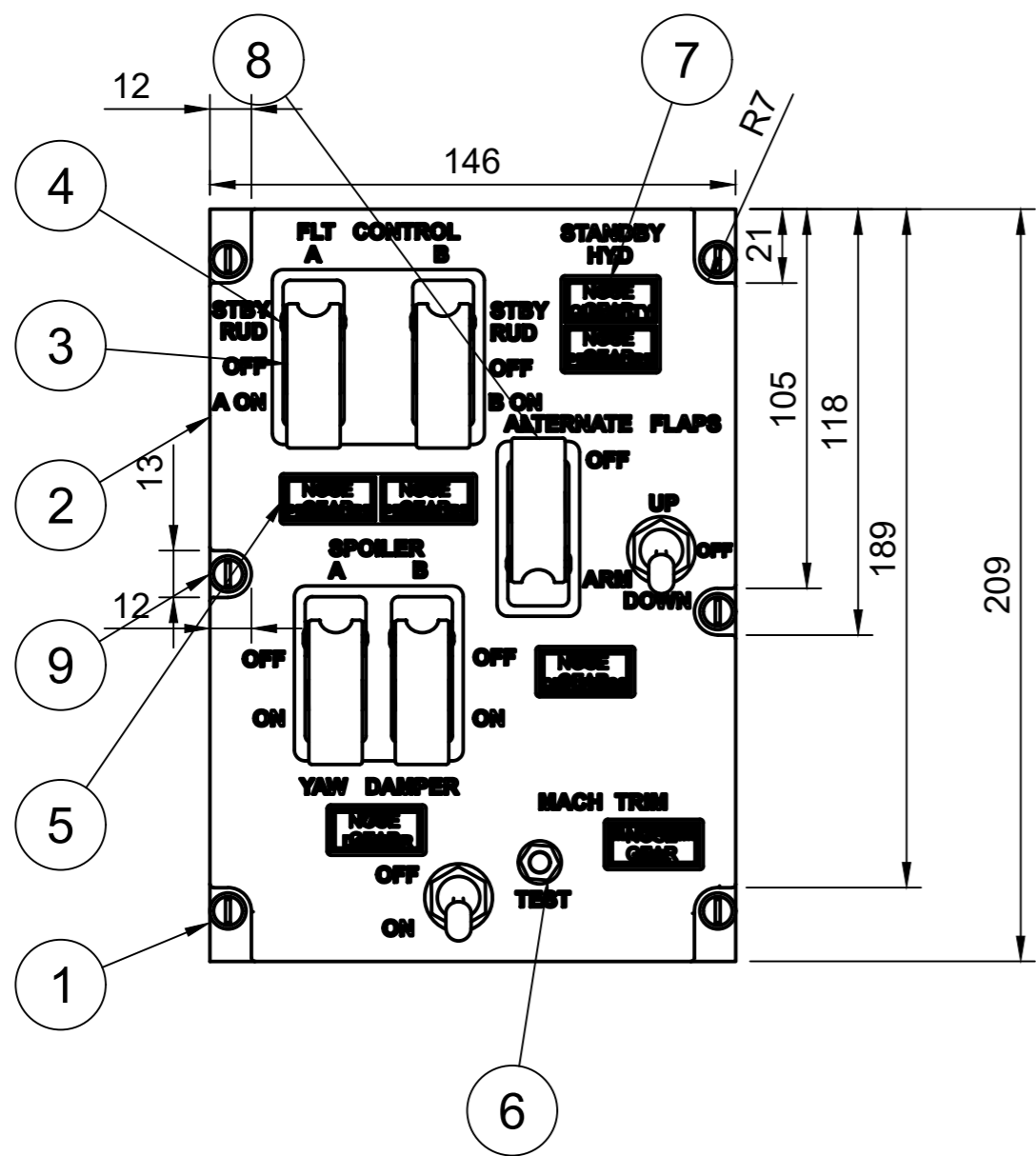
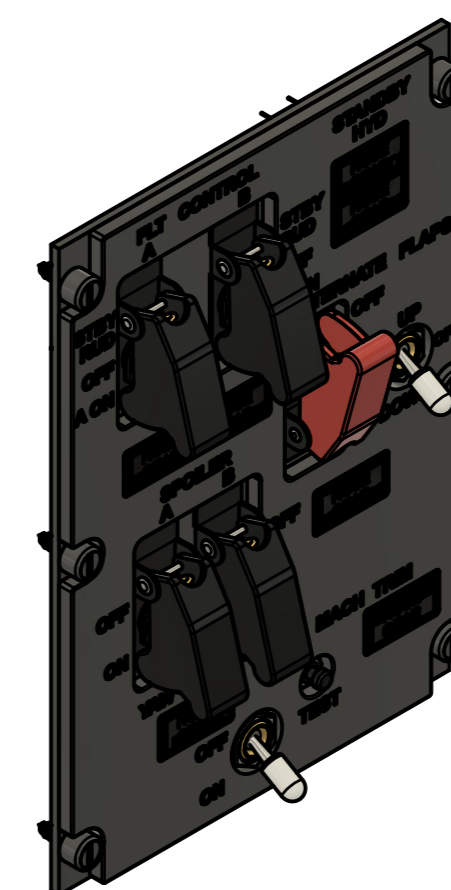

Parts List		
Item	Qty	Part Number
1	1	3mm Perspex
2	1	5mm Perspex
3	7	TOGGLE SWITCH LARGE (NOSE STEERING)
4	4	SAFETY SWITCH GUARD BLACK v1
5	7	ANNUNCIATOR BOX V1
6	1	ELEC PUSH BUTTON
7	1	Component6
8	1	SAFETY SWITCH GUARD BLACK v1 (1)
9	6	DZUS FASTENER PLASTIC

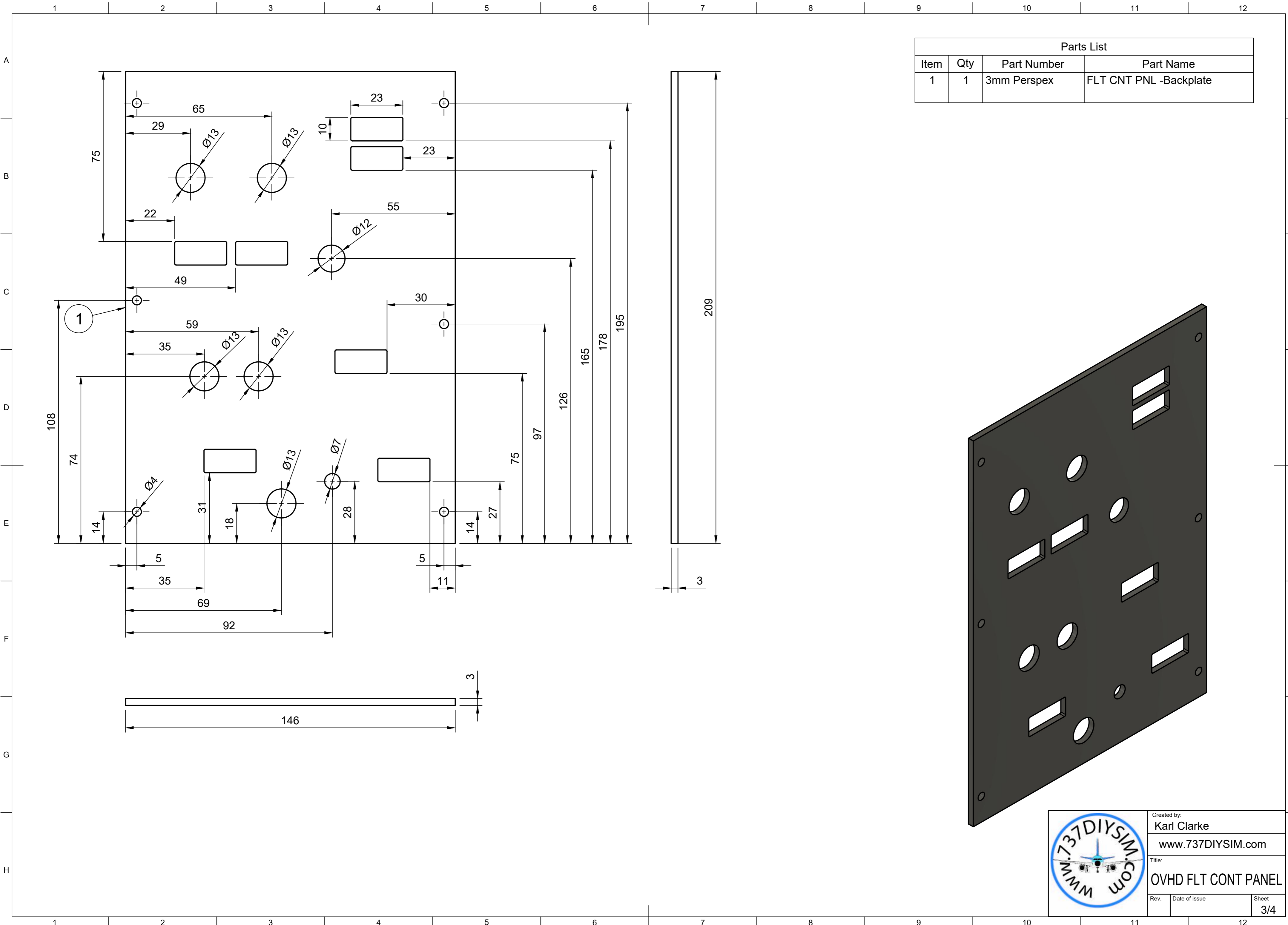

Created by:		
Karl Clarke		
www.737DIYSIM.com		
Title:		
OVHD FLT CONT PANEL		
Rev.	Date of issue	Sheet
		2/4

Created by:
Karl Clarke
www.737DIYSIM.com
Title:
OVHD FLT CONT PANEL
Rev. Date of issue Sheet
3/4

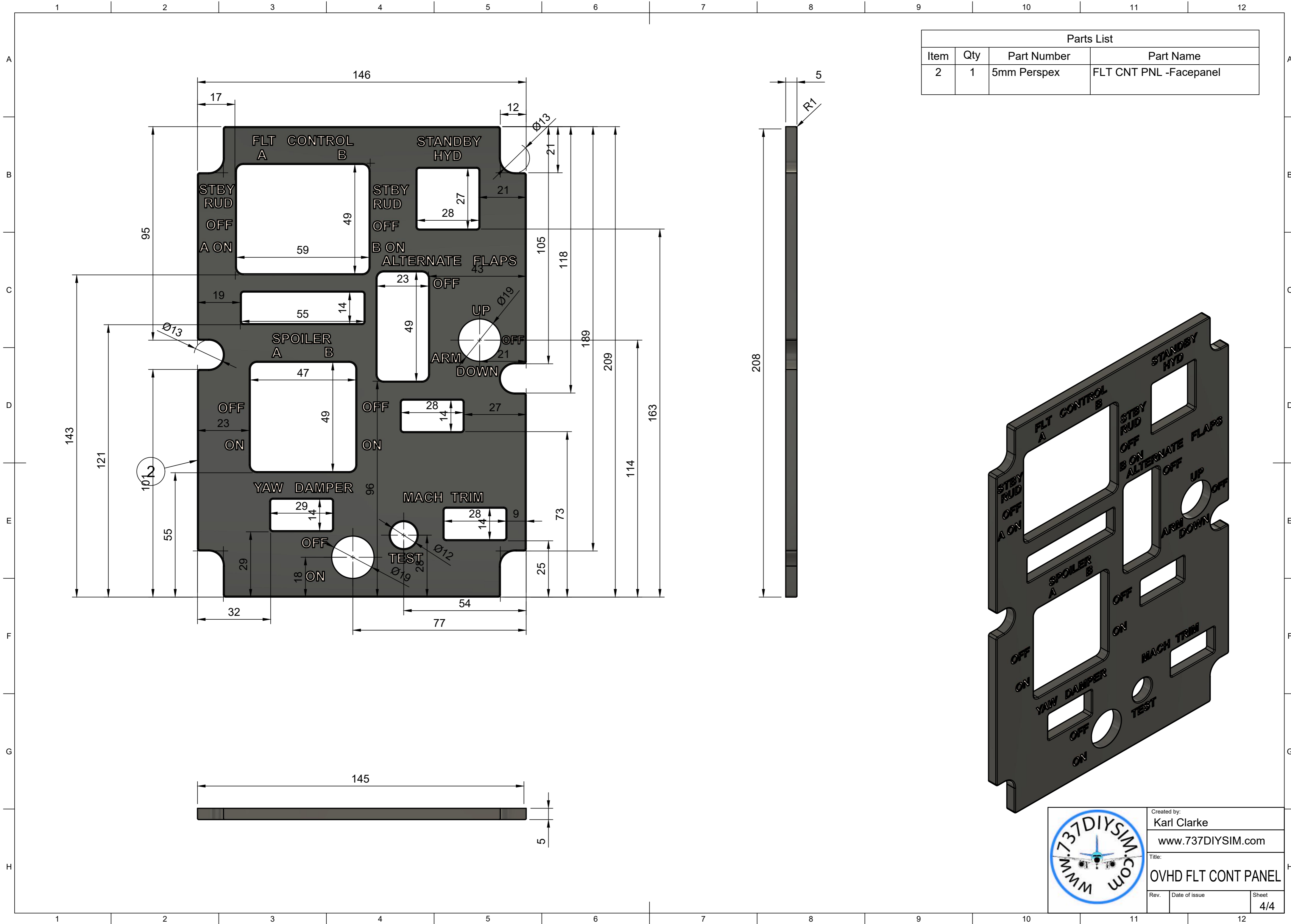

Parts List			
Item	Qty	Part Number	Part Name
2	1	5mm Perspex	FLT CNT PNL -Facepanel

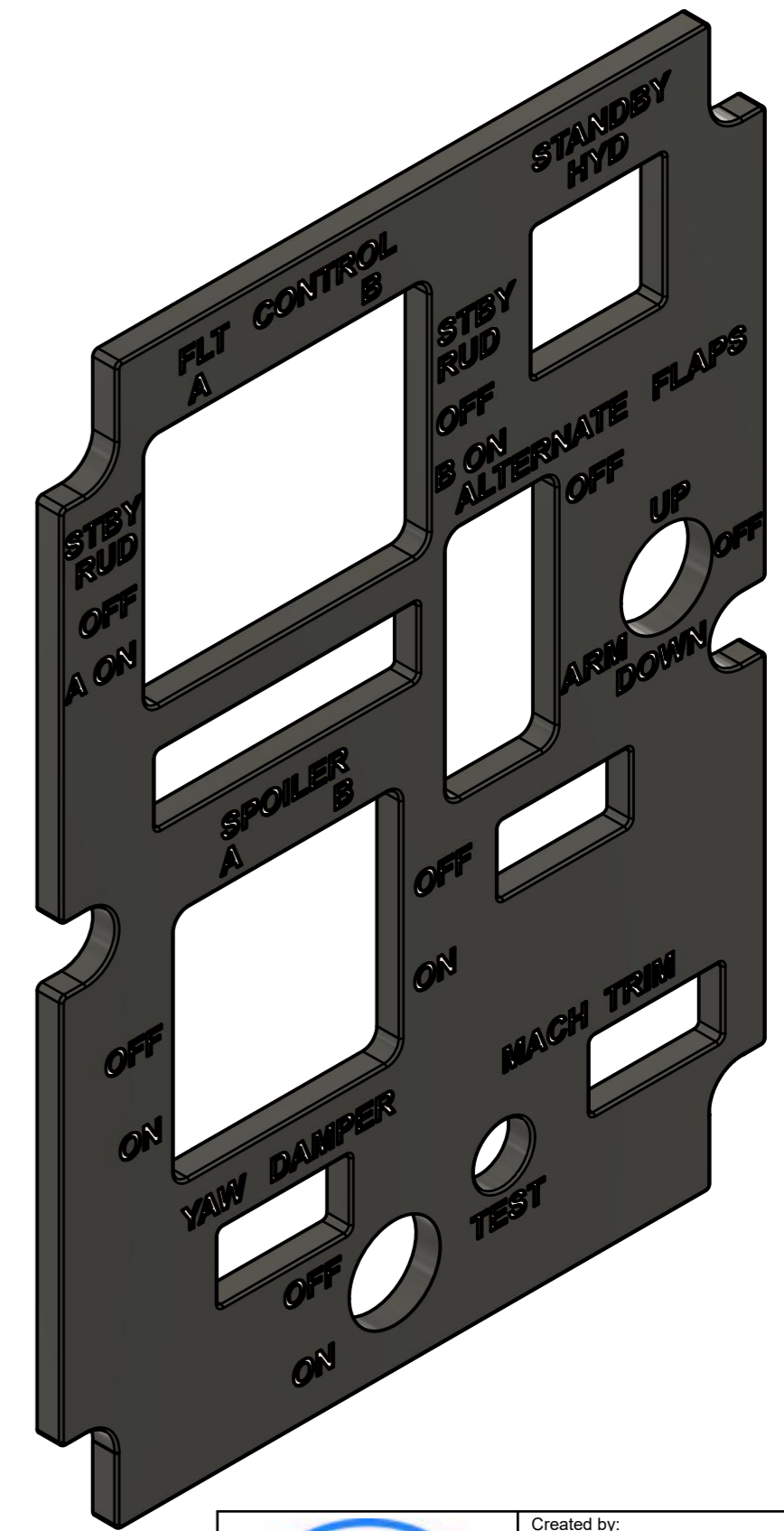

Created by: Karl Clarke		
www.737DIYSIM.com		
Title: OVHD FLT CONT PANEL		
Rev.	Date of issue	Sheet 4/4