

Parts List		
Item	Qty	Part Number
1	1	BACKPLATE
2	1	FACEPLATE
3	5	TOGGLE SW WTE CAP
4	2	ELEC PUSH BUTTON JNTS
5	1	ANNUNICATOR BOX BLUE
6	4	ANNUNICATOR BOX AMBER
7	1	SAFETY SWITCH GUARD BLACK
8	2	POTENIOMETER
9	1	12 POS ROTARY SW NEW
10	3	737 General Knob
11	1	LIGHT CASE
12	9	M4 X 18MM
13	2	M4 NUT

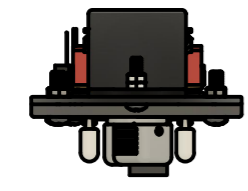

Created by:		
Karl Clarke		
www.737DIYSIM.com		
Title:		
OVHD CENTRE PANEL		
Rev.	Date of issue	Sheet
		1/4

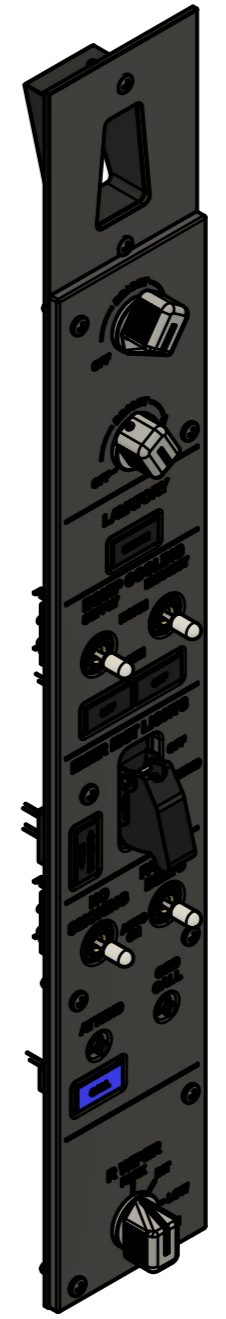
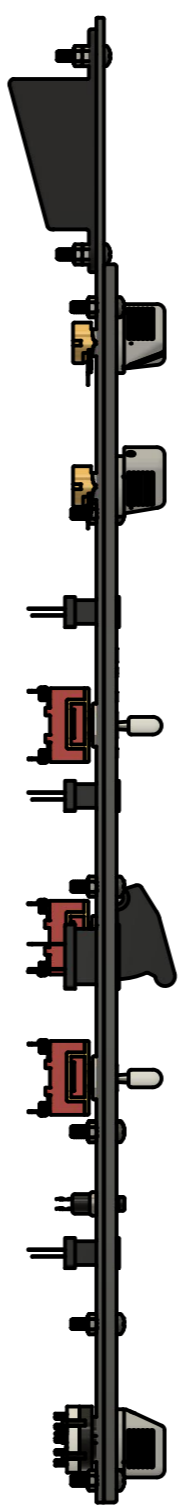
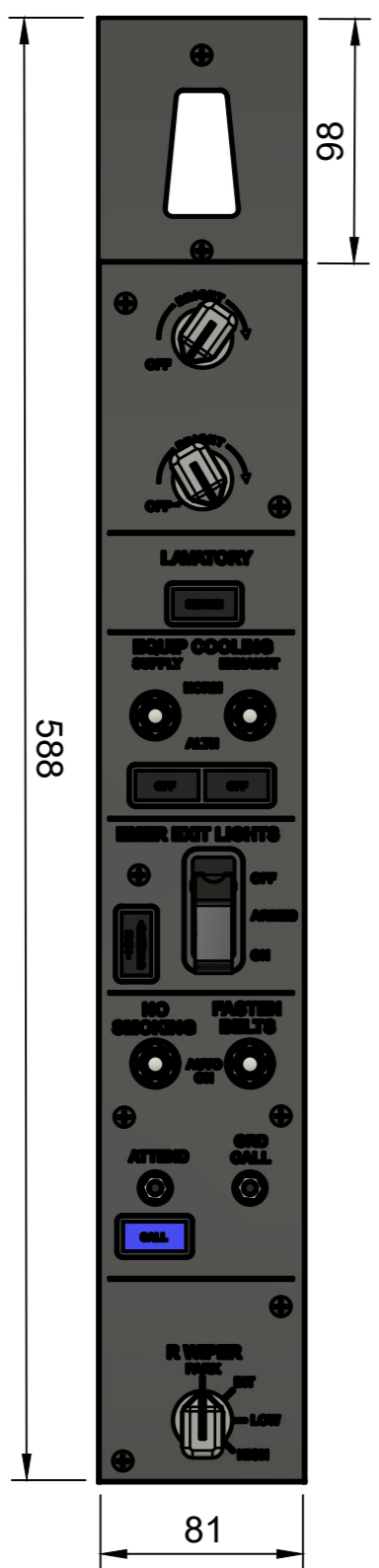
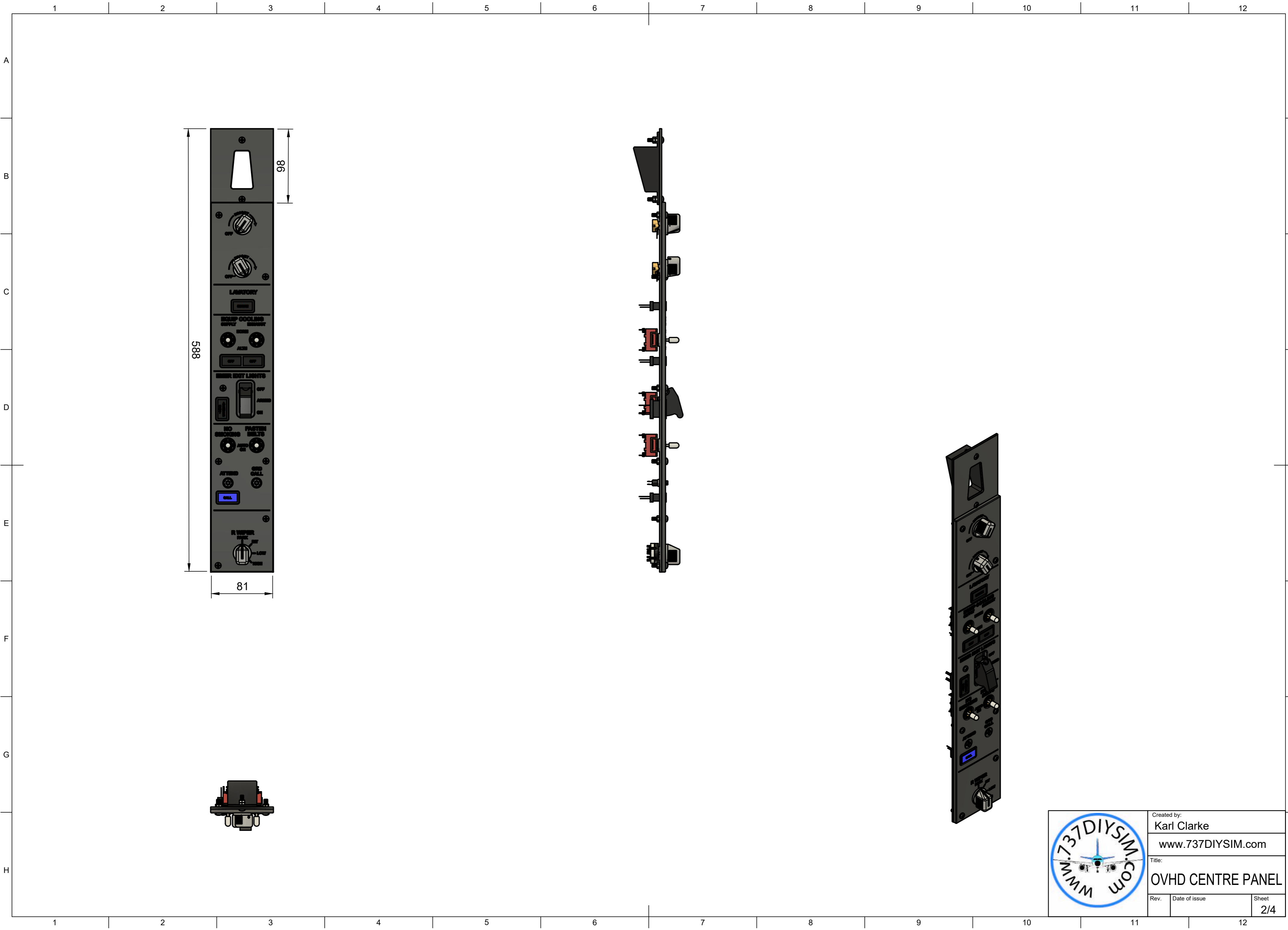

Created by:		
Karl Clarke		
www.737DIYSIM.com		
Title:		
OVHD CENTRE PANEL		
Rev.	Date of issue	Sheet
		2/4

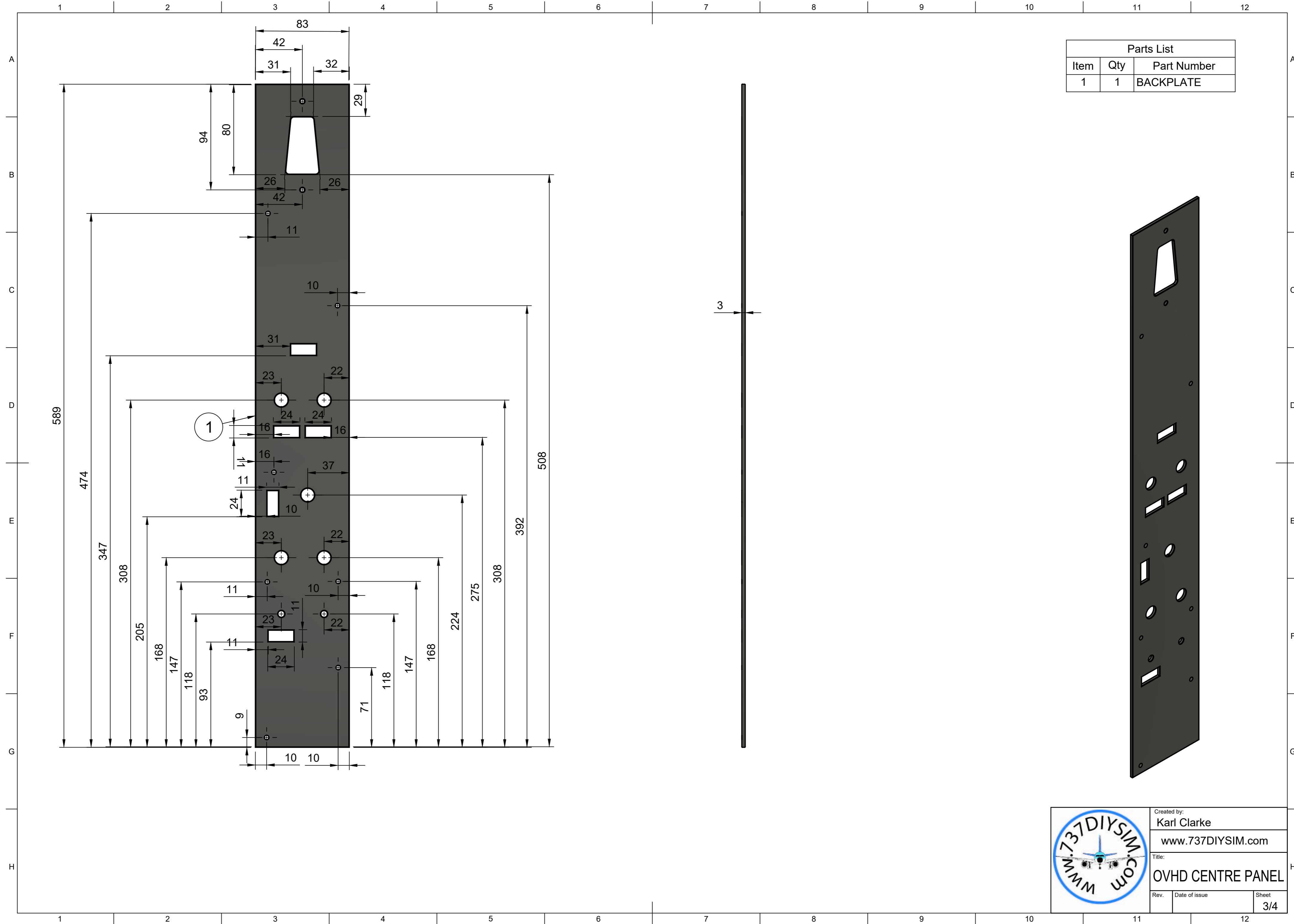

Parts List		
Item	Qty	Part Number
1	1	BACKPLATE



Created by: Karl Clarke		
www.737DIYSIM.com		
Title: OVHD CENTRE PANEL		
Rev.	Date of issue	Sheet 3/4

Parts List		
Item	Qty	Part Number
2	1	FACEPLATE

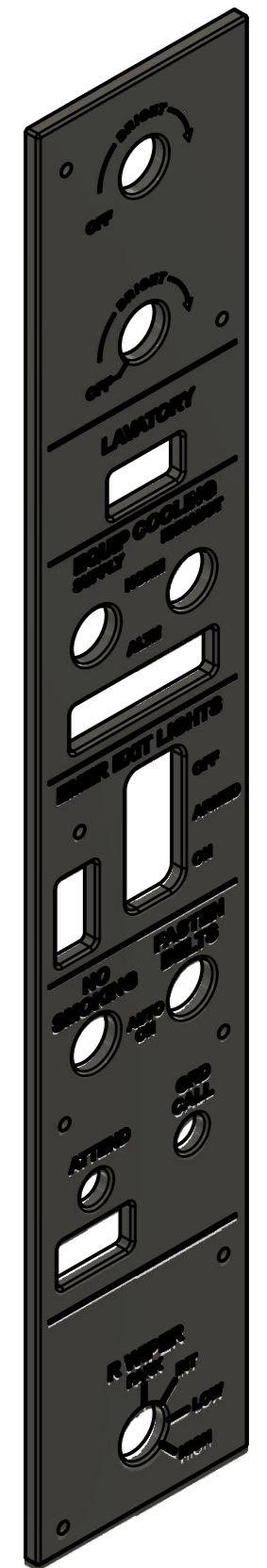
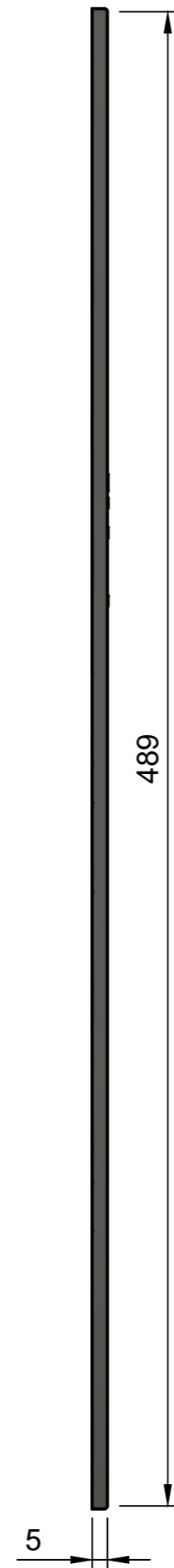
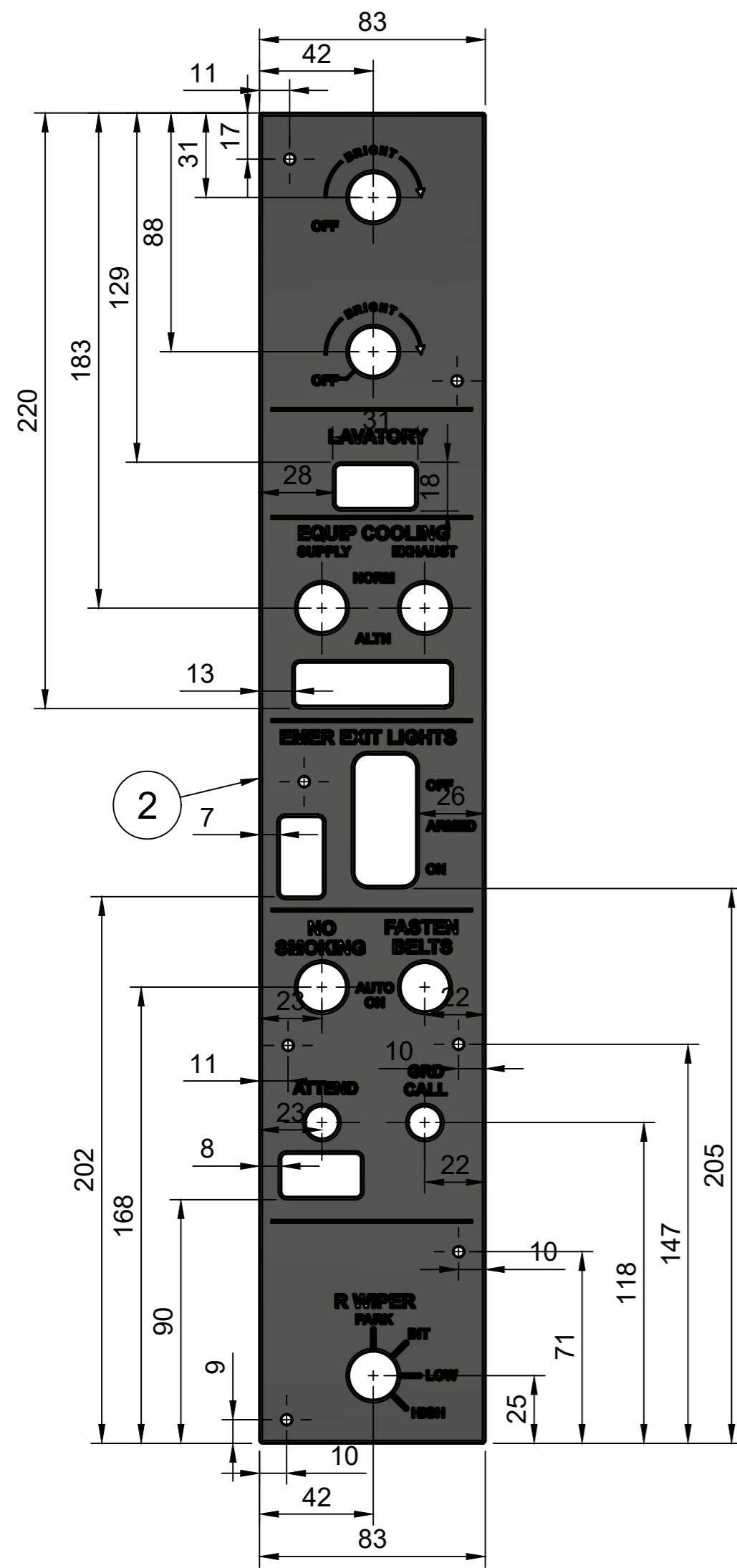

Created by:  
Karl Clarke  
www.737DIYSIM.com  
Title:  
OVHD CENTRE PANEL  
Rev. Date of issue Sheet  
4/4